

Figure 1:

Determine location for installation of the basin, and mark a line for what would be the actual final height of basin for use once installed. Measure down 87mm from this line, and mark a line for the installation of basin brackets.

- The bracket installation line must be horizontal and level.

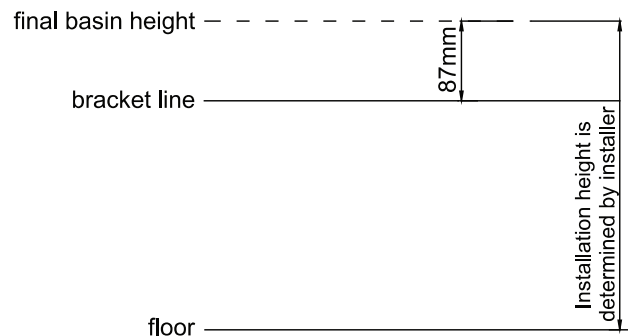

Figure 1

Figure 2:

Basin brackets should be separated by a distance of 220mm. Mark vertical lines at these points, then position the bracket onto the wall as shown in the diagram, and then based on the bracket position mark the installation holes. Fix brackets to the wall using appropriate tools, and fixing bolts for installation surface.

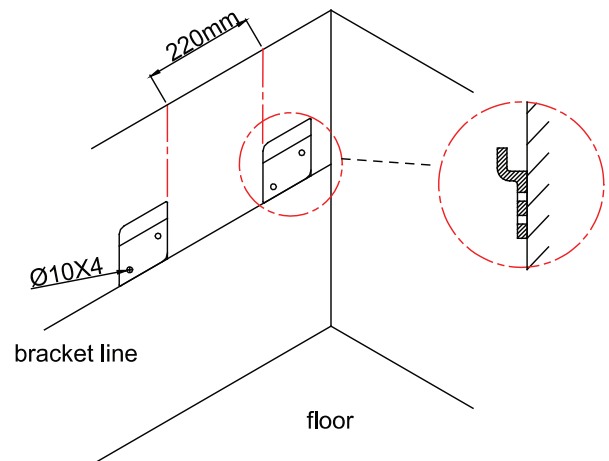

Figure 2

3:

After the installation of the brackets, hang the basin into position, and check that the basin fits well. Mark the basin fixing holes through the basin, and then remove basin. Using appropriate tools and fixing bolts for the installation surface drill and prepare for final fitting.

4:

Finally hang the basin to the brackets, and fix the basin thru the holes using appropriate fixing nuts. After this install tap and waste.

- Installation should be completed by a suitable qualified person.
- Tools and fixing bolts for installation are not supplied, and should be selected by installer based on installation surface.