

Product No. **8265-801-12**
 S No.
 EAN No. **7312908265126**



Opus 200 /100 LED

Opus 200 LED is an elegant cylindrical formed light fitting. Its timeless design is suitable for wall or ceiling installation, both indoors and outdoors. Equipped with a LED module, 12W.

Specification

Base material	Porcelain
Light source free **	LED module, 12W, flicker
Luminaire lm	853
Lm Light source	1300lm
Color temp.	2700K
MacAdam	3 SDCM
Lifetime	50 000 h
Ra (CRI)	Min 90
Dimmable	Yes
Voltage	230V
Installation	Ceiling/wall
Base colour	Grey NCS S 6005-G50Y
Safety class	I
Protection class	IP44
Energy class	E
T _a	-30 - +25
Height	100
Diameter	202
Glass	Matt opal
Thread	185,5 mm
Weight	1,94 kg
Design	Duoform

Technical information

Two Ø 6 mm holes for installation, CC measurement 133 mm, alternatively two hidden holes Ø 5 mm, CC measurement 70 mm. One bottom inlet for two mains supply cable. Connect to terminal of max 2 x 2,5 mm². Bridging is possible. Bottom inlet and three knock out openings.

Maintenance

Switch off the power to the fixture. Remove the shade and clean it. Do not use cleaning agents containing solvents. Change the LED module if necessary. Check the gasket and change it if necessary. Replace the shade.

Spare parts

Shade: 1-6186-30
 Gasket: 3431
 LED module: Art nr: 1-54052-927

Installation

Insert the main supply cable through the bottom inlet. Fix the light fitting to a wall or ceiling with suitable screws, make sure that the arrow and text UP on the bottom of the base points upwards for wall installation. Pull the cables through the opening next to the terminal block on the LED module and then attach the LED module with the two screws provided. Connect the wires to the terminal block. Fasten the shade by turning it clockwise. Make sure that gasket between the glass and base is in place.

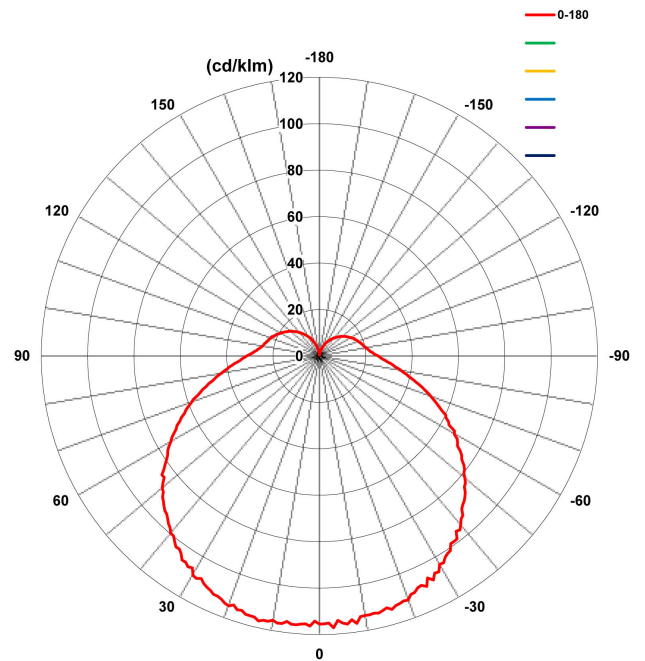
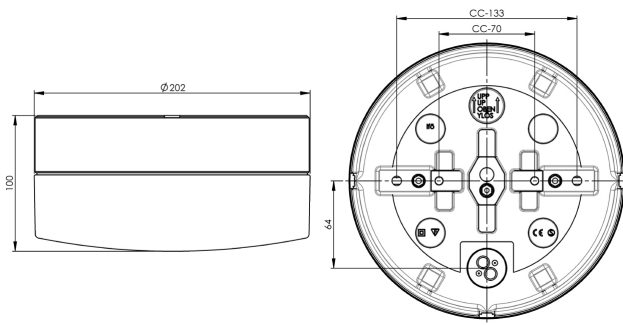

*** The device must under no circumstances be connected to the same phase as a magnetic ballast or other older fluorescent luminaires as these luminaires can generate overvoltage transients outside of EU regulatory standards when switched off or on. The luminaire can permanently damage or completely cease to function when connected.*

If the luminaire is modified the person responsible for the modification shall be considered manufacturer. Subject to errors in text. We reserve the right to change the technical specifications (without notice).

