

Product No. **7266-500-16**  
 S No. **4211992**  
 EAN No. **7312907266261**



# Opus 200/190

Opus 200 is an elegant cylindrical formed light fitting. Its timeless design is suitable for wall or ceiling installation, both indoors and outdoors.

## Specification

Base material	Porcelain
Lampholder	E27
Light source	Max 75W (not incl.)
Voltage	230V
Installation	Ceiling/wall
Base colour	Black NCS S 9000-N
Safety class	II
Protection class	IP44
Energy class	-
T <sub>a</sub>	-30 - +25
Height	194 mm
Diameter Ø	202 mm
Glass	Matt opal
Thread	185,5 mm
Weight	2 kg
Design	Duoform

## Installation

Insert the mains supply cable through the bottom inlet. Push the silicone sleeves included over the leads. Fix the light fitting to the wall or to the ceiling with suitable screws, make sure the arrow and text UP on the bottom of the base points upwards for wall installation. Connect the leads to the terminals. Fasten the lamp holder. Insert a light source and then fasten the shade by turning it clockwise. Make sure the gasket between the glass and base is in place.

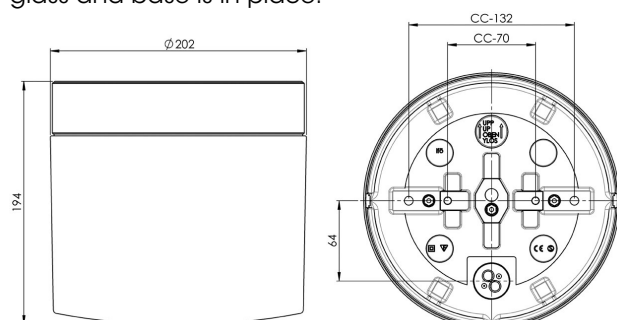

## Technical information

Silicone gasket between glass and base. Four Ø 5mm holes for installation. CC measurements 133 mm or 70 mm. One bottom inlet for two mains supply cable. Terminal connection of max 2 x 1,5 mm<sup>2</sup>. Bridging is possible. Bottom inlet, three knock out openings.

## Maintenance

Switch off the power to the fixture. Remove the shade and clean it. Do not use cleaning agents containing solvents. Change the light source if necessary. Check the gasket and change it if necessary. Replace the shade.

## Spare parts

Shade: Part no 1-6185-30  
 Gasket: Part no 3431

*If the luminaire is modified the person responsible for the modification shall be considered manufacturer. Subject to errors in text. We reserve the right to change the technical specifications (without notice).*