

Product No. **8201-800-16**
 S No.
 EAN No. **7312908201865**



Opus 100 /100 LED

Opus 100/100 LED is an elegant, cylindrical shaped light fitting. Its timeless design it suitable for wall or ceiling installation, both indoors and outdoors.

Specification

Base material	Porcelain
Light source	LED module, 4W **
Luminaire lm	344
LED module lm	500
Color temp.	3000K
MacAdam	3 SDCM
Lifetime	50 000 h
Ra (CRI)	Min 80
Dimmable	Yes
Voltage	230V
Installation	Ceiling/wall
Base colour	Black NCS S 9000-N
Safety class	I
Protection class	IP44
Energy class	A+
T _a	
Height	95
Diameter	97
Glass	Matt opal
Thread	84,5
Weight	0,77 kg
Design	Duoform

Installation

Insert the mains supply cable through the bottom inlet. Fix the light fitting to the wall or to the ceiling with suitable screws. Connect the leads to the terminal block. Fasten the LED module and then fasten the shade by turning it clockwise. Make sure the gasket between the glass and base is in place.

Technical information

Silicone gasket between glass and base. Four Ø 5mm holes for installation. Two holes CC measurement 60-66 mm, alternatively two hidden holes CC measurement 70 mm. One bottom inlet for two mains supply cable. Terminal block for connection of 3 x 2,5 mm². Bridging is possible. Bottom inlet. No knock out openings.

Dimmer

Vadsbo LD220, 1-7 pc
 Vadsbo LD220WCM, 1-10 pc
 Vadsbo VD200, 1-6 pc
 Schneider CCT99100, 1-10 pc

Maintenance

Switch off the power to the fixture. Remove the shade and clean it. Do not use cleaning agents containing solvents. Change the LED module if necessary. Check the gasket and change it if necessary. Replace the shade.

Spare parts

Shade: Part no 1-6180-30
 Gasket: 02786-1
 LED module: 1-54053-830

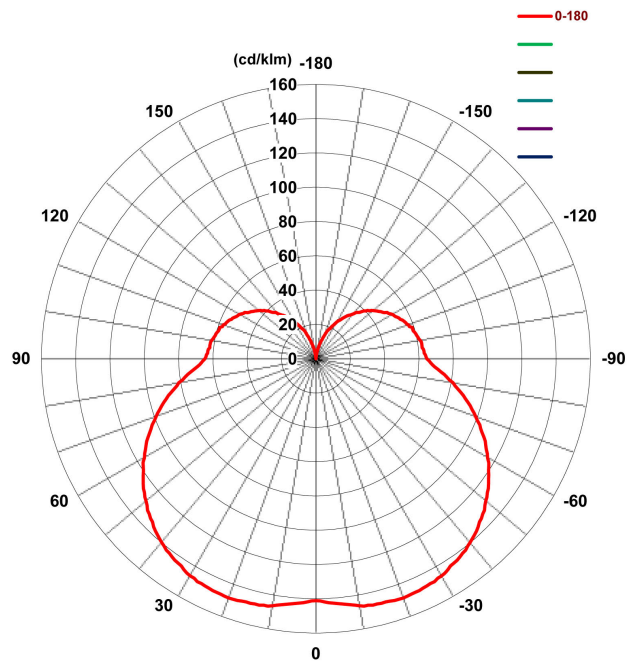
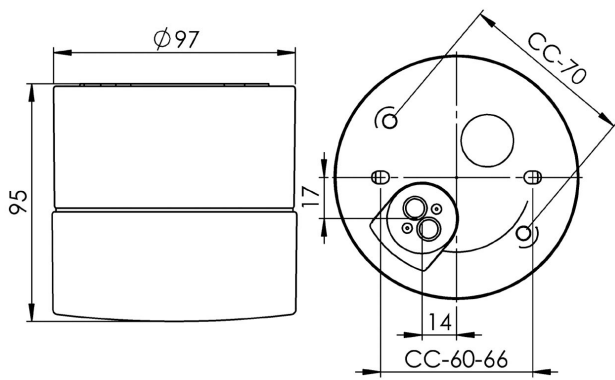

*** The device must under no circumstances be connected to the same phase as a magnetic ballast or other older fluorescent luminaires as these luminaires can generate overvoltage transients outside of EU regulatory standards when switched off or on. The luminaire can permanently damage or completely cease to function when connected.*

If the luminaire is modified the person responsible for the modification shall be considered manufacturer. Subject to errors in text. We reserve the right to change the technical specifications (without notice).

