

Solenne 250/155 LED DALI 3000K

Solenne is designed by Kauppi & Kauppi and includes a total of seven lighting fixtures, all with generous matt opal glass shades and black or white glazed porcelain bases. Four of the fixtures follow our traditional range for ceiling, wall, and facade with IP44 ratings suitable for both indoor and outdoor installations. The collection also includes three more novel types of lighting fixtures, taking our pressed porcelain to new indoor contexts. Solenne includes a grand pendant with a corresponding porcelain ceiling cup, a new table luminaire with a wooden base, and Ifö Electric's very first floor lamp.

EAN / GTIN	7312908441957
E-number	7509647
Article no.	8441-8001-16
Type designation	51765/DALI



Specification

Base colour	Black (NCS S 9000-N)
Glass	Matt opalglas
Glass thread (mm)	123,5 mm
Glass gasket	Silicone
Diameter (mm)	250
Height (mm)	156
Lamp holder	LED
Light source	LED module, 10W **
Colour temperature	3000K
MacAdam	3 SDCM
Life span	L80/B10: 47 000 h
Ra	Min 90
Lighting control	LED module, 10W **
Rated voltage	230V
Dimmable	DALI PHM126 min 3%
IP class	IP44
Insulation class	I
Energy class	E
D class	No
IK class	IK02
Ta	-30 - +25
Installation	Ceiling/wall
CC measurement (mm)	60-66, 70
Knock out opening	4
Cable inlet	Bottom inlet
Cable glands	Bottom inlet
Bridging	Yes
Surface mounted cable	Yes
Connection	Terminal block
Family	Solenne
Design	Kauppi & Kauppi

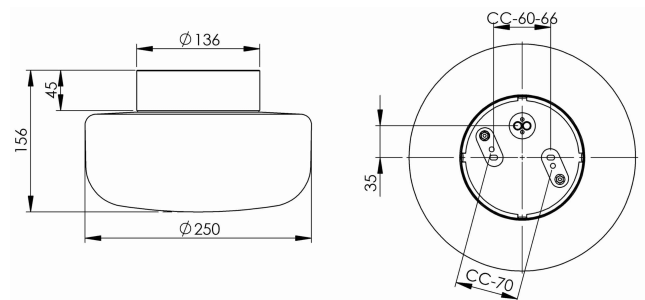

Maintenance

Disconnect the luminaire. Remove the shade and clean it. Do not use cleaning agents containing solvents. Change the light source if necessary. Check the gasket and change it if necessary. Replace the shade.

Spare parts

Shade Solenne 250, Article no.: 1-6164-30
 Gasket silicone for thread 123,5 mm, Article no.: 02789
 LED module 10W DALI 3000K, Article no.: 1-54062-1930

** The device must under no circumstances be connected to the same phase as a magnetic ballast or other older fluorescent luminaires as these luminaires can generate overvoltage transients outside of EU regulatory standards when switched off or on. The luminaire can permanently damage or completely cease to function when connected.

If the luminaire is modified the person responsible for the modification shall be considered manufacturer. Subject to errors in text. We reserve the right to change the technical specifications (without notice).